

CATHODE SPUTTERING, A COMMERCIAL APPLICATION

By H. F. FRUTH

WESTERN ELECTRIC, CHICAGO

(Received February 15, 1932)

ABSTRACT

The theory of cathode sputtering with the advantages and limitations in the application of this process is discussed, followed by a description of the commercial equipment and methods for applying gold electrode surfaces to diaphragms of certain types of microphones. By proper design of the vacuum chamber and the inside parts, a fairly uniform discharge current density and a uniform deposit is obtained. A constant sputtering rate is produced by the use of a bleeder valve which maintains a proper residual pressure. Adherence and continuity are obtained by the use of a special cleaning process. An extensive bibliography on cathode sputtering is included.

INTRODUCTION

ALTHOUGH the process of electrostatic deposition of metals by high voltages in a partial vacuum, commonly known as cathode sputtering, has been known for more than a half century, it has heretofore found but little commercial application. Rather extensive use of it has, however, been made in physics research laboratories for such purposes as the production of highly reflecting surfaces on mirrors and prisms, for spectrometers, interferometers, etc., and the making of extremely thin metal films for fundamental studies in atomic structure and electron theory. Sputtering has also been used in the manufacture of very fine conducting quartz fibres for suspensions in sensitive instruments such as quadrant and string electrometers, galvanometers, and electrocardiographs, and, to some extent, for etching certain metals.

In the following paragraphs, it is intended to give a brief explanation of the process and a description of a commercial application in the production of diaphragms for certain microphones.

THEORY

Some fifty years ago, various investigators working on high voltage discharges in vacuo discovered that disintegration of the cathode occurs for nearly all metals and that the removed metal is deposited in a very fine state of subdivision on nearby objects. Various theories have been formulated as to the mechanism of this phenomenon. Some investigators have attempted to explain it by stating that it is a type of electrical evaporation where the electrical potential is analogous to the temperature potential in ordinary thermal evaporation. More plausible theories, recently advanced, are that the metal atoms or particles leave the cathode as a result of positive ion bombardment, either as a result of single impacts or by cumulative action. This does not seem to hold for all metals and residual gases, and it has been suggested that

in some cases sputtering is due to the absorption of radiation produced when the gas ions are stopped at the cathode.

There has also been a great deal of controversy as to the structure of the sputtered film. Most of the more recent evidence indicates that the films are of a crystalline nature.

ADVANTAGES OF SPUTTERING OVER OTHER METHODS OF METALLIZING

In general, cathode sputtering cannot compete with the more common processes of metallic deposition, but in many special cases it can be employed where other methods are inapplicable. This is especially true (a) when metals are to be deposited upon non-conductors, (b) when the surfaces to be metallized would be injured by contact with chemical solutions or high temperature, (c) when either a very thin continuous metal coat or a very smooth, highly reflecting coat is desired, (d) when metals are to be deposited that are very difficult to deposit in any other manner, such as, silicon, tellurium, or

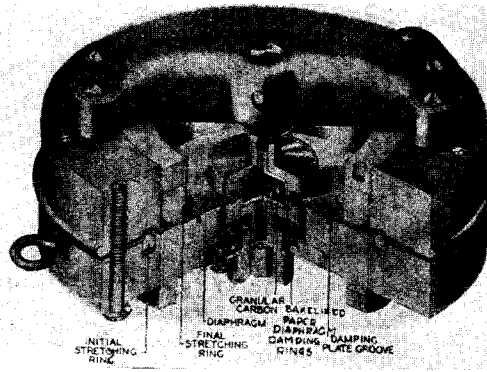

Fig. 1. Carbon broadcasting transmitter.

selenium, (e) when a metal is to be deposited upon another metal far removed from it in the electrochemical series, such as, gold or platinum upon aluminum or magnesium. In such cases, electrolytic corrosion is very apt to occur in the presence of moisture or traces of electrolyte.

COMMERCIAL APPLICATION

Cathode sputtering has been used commercially by the Western Electric Company with excellent results in the manufacture of diaphragms for carbon broadcasting transmitters, illustrated in Fig. 1. This type of microphone consists essentially of a tightly stretched duralumin diaphragm located between two chambers containing granular carbon. The manner in which the double button type of microphone is connected to the amplifiers of the broadcasting, public address, or sound picture system is schematically shown in Fig. 2. Those parts of the diaphragm which come in contact with the carbon are covered with gold, a metal which has been found to be ideally suited for microphonic purposes. It is exceedingly important that the gold coating be

continuous and remain adherent, for if the carbon should make contact in a number of places with the duralumin, it is quite likely that the microphone would be noisy and therefore unfit for use.

When the gold spots were formed by the plating process previously used, considerable trouble was experienced because of such defects as blisters, peeling, and pin holes probably due largely to electrolytic corrosion. The substitution of the sputtering process has practically eliminated such defects. Some additional advantage over electrolytic plating is obtained in that a thinner

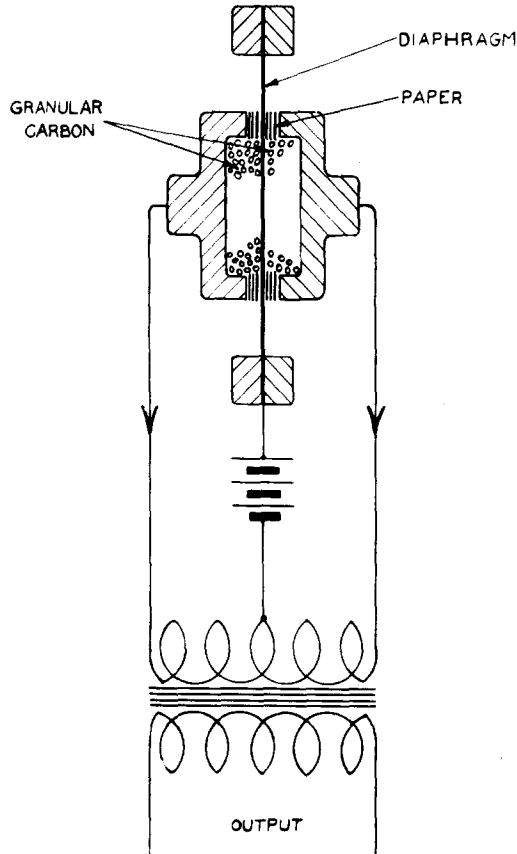

Fig. 2. Diagram of connections between double button type of microphone and amplifier.

continuous film can be deposited, making it possible to stretch the diaphragm to a higher natural frequency with less tension. This decrease in tension has resulted in a smaller frequency loss due to fatigue. The introduction of the sputtering process has, therefore, not only improved the quality of the microphone, but lengthened its life.

EQUIPMENT AND METHOD

In order to apply a satisfactory gold electrode surface to the duralumin diaphragm by cathode sputtering commercially, it was necessary to develop

a special cleaning process for the diaphragms and suitable equipment with multiple sputtering electrodes.

To insure proper continuity and adherence of the gold to the duralumin, the glossy roll finish on the duralumin is broken up by means of a brass wire scratch brush to give a matte surface. The diaphragms are then scrubbed in acetone, rinsed in ether, and rubbed dry with filter paper to remove all traces of oil or grease. Great care is then taken to keep the spot to be coated free from all contaminations before sputtering.

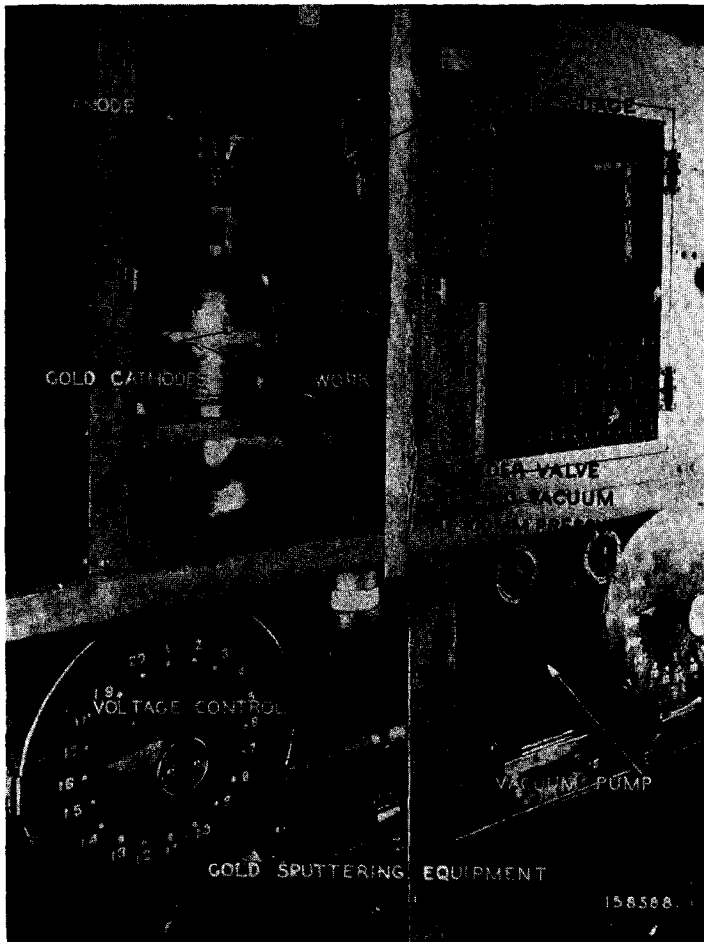

Fig. 3. Commercial sputtering unit.

The unit developed for commercial sputtering is shown in operation in Fig. 3. A two-gallon bell jar fitted upon a heavy ground Pyrex glass plate contains six glass-covered aluminum cathodes, the exposed parts of which are fitted with renewable gold disks (Fig. 4). An adjustable aluminum stand to hold the diaphragm fixture and shield is placed upon the plate directly below

the cathodes. The shield covers all of each diaphragm except a central circular spot about $3/4$ " in diameter. A vacuum is produced by means of a Megavac pump connected to the bell jar by $5/8$ " Pyrex glass tubing, which is made as short as possible to facilitate rapid pumping. In the vacuum system are a small rotating McLeod gauge, a trap, a bleeder valve, and an anode. The anode consists of a 20-turn, $1/2$ " helix of No. 14 aluminum wire sealed into a one-inch tube at some distance from the bell jar. The end of the helix is

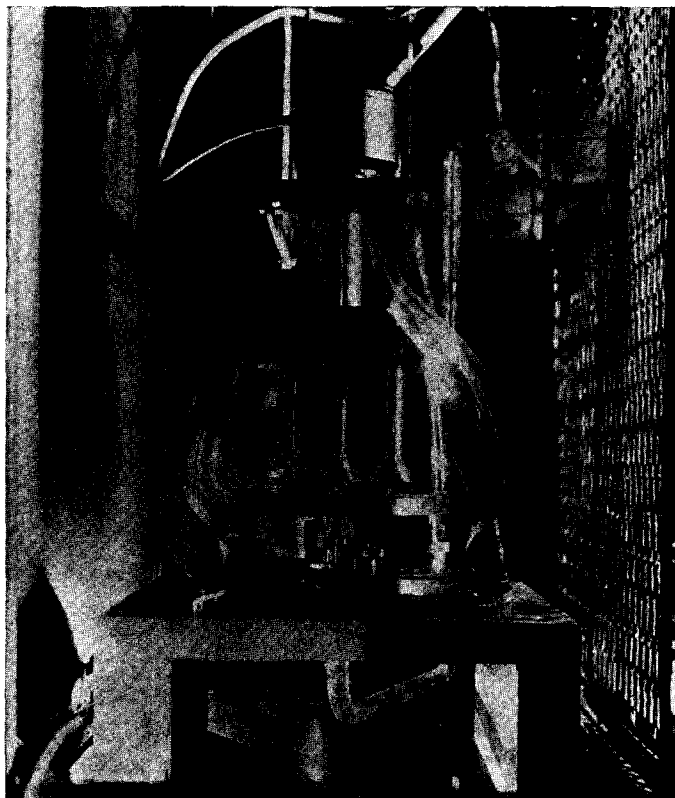

Fig. 4. Cathodic sputtering unit for microphone diaphragms.

shielded against high current density by a flanged piece of glass tubing. This type of anode has a life of at least two thousand hours.

In order to maintain a constant residual gas pressure, the pump is operated continuously and air is allowed to leak slowly through the bleeder valve which is located near the pump. This practice was found necessary in order to overcome variations in pressure due to the early evolution of gases and the later cleanup usually accompanying electrical discharges in vacuo. The valve is of rugged construction as shown in Fig. 5 and consists of a standard No. 0 taper pin about $2\ 1/2$ inches long, very closely lapped into a bronze bushing. A pressure of 0.100 ± 0.005 mm is readily maintained by this method. After a new charge has been placed in the bell jar, the bleeder valve

is temporarily cut off by closing a stop cock so that the required vacuum can be more quickly obtained. By this means, sputtering can be started in about four minutes after the bell jar has been placed in position.

The discharge is produced by means of a 1/2 k-v-a transformer which steps up the voltage from 110 to 10,000 volts and is regulated by means of a rheostat in the primary. Safety for the operator is insured by having all high tension leads and terminals enclosed in an expanded metal cage. The door operates a switch in the primary circuit, so that as the door is opened, the circuit is broken.

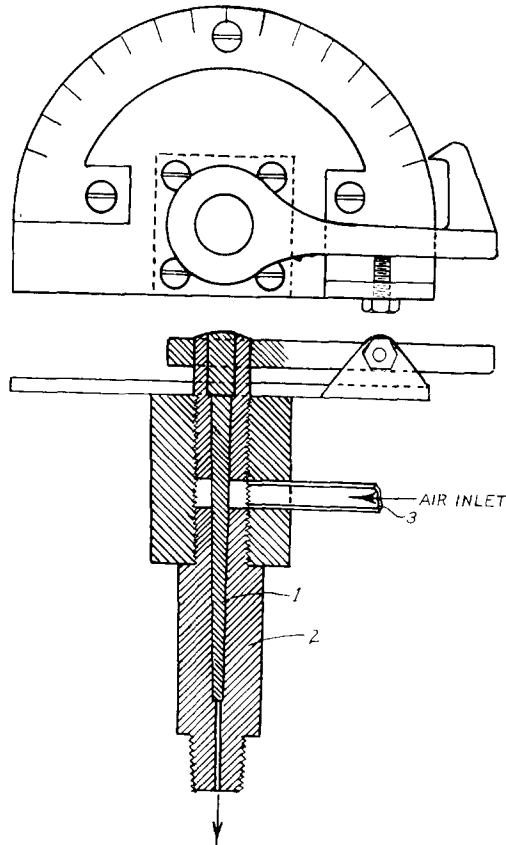

Fig. 5. Bleeder valve.

In order that equal amounts of metal might be evenly deposited on each of the six diaphragms, it was necessary to determine experimentally the relative spacing of the electrodes, and the shape and the size of the shields, stands, and bell jar which would give a uniform current distribution. The best results were obtained by placing the diaphragms $5/8$ " from the cathodes, which are arranged symmetrically, by maintaining the pressure at 0.10 ± 0.05 mm, by having a $1/2$ " hole in the center of the diaphragm holder and shield, and a one inch clearance between their outer rims and the bell jar.

In commercial practice a single operator runs three units simultaneously and produces about 90 broadcasting microphone diaphragms a day. These diaphragms require a gold spot on both sides which necessitates breaking the vacuum and turning the parts over. The time not occupied in loading the fixtures and operating the equipment is taken up in preparing diaphragms for sputtering, marking, and packing the finished product. It requires about forty minutes to deposit from three to five mg of gold per spot. Although this deposit is not more than 0.001 mm thick, it is very continuous, adherent, and altogether suitable as a microphonic electrode surface. (Fig. 6.)

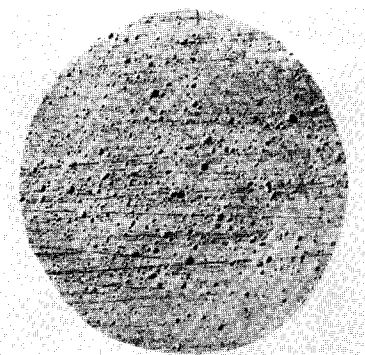

Fig. 6a. Representative gold plated diaphragm surface after 3 months service showing blisters.

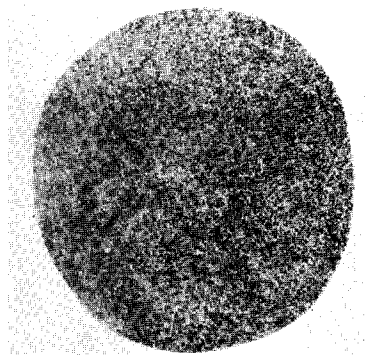

Fig. 6b. Representative gold sputtered diaphragm surface after 3 months service showing no blisters.

This equipment has been in successful operation for a number of years in the production of microphone diaphragms.

BIBLIOGRAPHY

- W. R. Grove, *Phil. Trans.* **1**, (1852).
 J. P. Gassiot, *Proc. Roy. Soc.* **9**, 146 (1858).
 Plucker, *Pogg. Ann.* **103**, 90; **104**, 116; **105**, 70 (1858).
 Gassiot, *Rep. of Brit. Assoc.* **2**, 38 (1861);
Fortschr. der Phys. **II**, 505 (1862).
 Wright, *Amer. Journ. of Sc. (Silliman)* **13**, 49; **14**, 169 (1877).
 Puluj, *Wien. Ber.* **81**, II, 864 (1880).
 Fr. Wachter, *Wied. Ann.* **17**, 903 (1882).
 E. Wiedemann, *Wied. Ann.* **20**, 756 (1883).
 Hittorf, *Wied. Ann.* **21**, 126 (1884).
 A. Kundt, *Wied. Ann.* **27**, 59 (1886) and *B. Dessau, Wied. Ann.* **29**, 353 (1886).
 W. Crookes, *Proc. Roy. Soc.* **50**, 88 (1891).
 Moser, *Wied. Ann.* **42**, 639 (1891).
 G. Granquist, *Ofvers. Svensk. Vetensk. Ak. Forh.* **54**, 575 (1897).
 G. Granquist, *Ofvers. Svensk. Vetensk. Ak. Forh.* **55**, 709 (1898).
 Wehnelt, *Wied. Ann.* **67**, 425 (1899).
 A. C. Longdon, *Phys. Rev.* **I**, **5**, 11, 40, and 84 (1900).
 J. Patterson, *Cam. Phil. Soc. Proc.* **V** **11**, 118 (1901).
 J. J. Thompson, *Cam. Phil. Soc. Proc.* **V** **11**, 120 (1901).
 Goldstein, *Verh. d. D. Phys. Ges.* 237 (1902).
 W. Wien, *Phys. Zeits.* **3**, 440 (1902).
 G. C. Schmidt, *Ann. d. Physik* **9**, 703 (1902).
 J. Tafel, *Ann. d. Physik* **11**, 613 (1903).
 L. Houllevigue, *Jour. de Phys.* **4-S**, 2 (1903).
 G. C. Schmidt, *Ann. d. Physik* **13**, 622 (1904).
 J. Tafel, *Ann. d. Physik* **14**, 206 (1904).
 L. Holborn und L. Austin, *Wissensch. Abhandl. d. Phys.-techn. Reichsanstalt*, **IV**, 101 (1904).
 S. Valentiner und R. Schmidt, *Ann. d. Physik* **18**, 187 (1905).

- J. J. Thomson, Proc. Cambridge Phil. Soc. **XIII**, 212 (1905); Chem. C.-B. **I**, 891 (1906).
- Ch. Maurain, C. R. **141**, 1223 (1905).
- J. Stark, "Electricity in Gases".
- J. J. Thomson, "Conduction through Gases".
- W. Ramsey, Proc. Roy. Soc. **77**, 148 (1906), Zeits. f. Physik **55**, 537 (1906).
- V. Kohlschutter und R. Muller, Zeits. f. Elektroch. **12**, 365 (1906).
- V. Kohlschutter, Zeits. f. Elektroch. **12**, 869 (1906).
- L. Houllevigue, Jour. de Phys. **6**, 596 (1907).
- V. Kohlschutter und Th. Goldschmidt, Zeits. f. Elektroch. **14**, 221 (1908).
- Th. Goldschmidt, Inaug.-Dissert. Strasburg i.E. (1908).
- Fr. Fischer und O. Hahnel, Zeits. f. Elektroch. **14**, 366 (1908).
- V. Kohlschutter, Zeits. f. Elektroch. **14**, 417 (1908).
- Fr. Fischer und O. Hahnel, Zeits. f. Elektroch. **14**, 433 (1908).
- V. Kohlschutter, Zeits. f. Elektroch. **14**, 437 (1908).
- V. Kohlschutter, Zeits. f. Elektroch. **14**, 681 (1908).
- B. Walter, Zeits. f. Electroch. **14**, 695 (1908).
- F. Fisher, O. Haehnel Zeits. f. Electroch. **14**, 677 (1908).
- Fr. Fischer, Zeits. f. Elektroch. **15**, 512 (1908).
- J. Stark, Zeits. f. Elektroch. **14**, 754 (1908).
- J. Stark, Zeits. f. Elektroch. **15**, 509 (1909).
- J. Stark, Univ. Berlin, Zeits. f. Electroch. **15**, (1909).
- Pfund, Phys. Rev. **28**, 324 (1909).
- J. Stark, Zeits. f. Electroch. **15**, 509 (1909).
- V. Kohlschutter, Zeits. f. Electroch. **15**, 316 (1909).
- L. Houllevigue, C. R. **148**, 1320 (1909) and 1237 (1910).
- V. Kohlschutter, Zeits. f. Elektroch. **930** (1910).
- V. Kohlschutter, Zeits. f. Elektroch. **17**, 393 (1911).
- H. V. Dechend und W. Hammer, Zeits. f. Elektroch. **17**, 235 (1911). (Ber. d. Naturf. Ges. zu Freiburg i.B. **18**, 127); vgl. auch Jahrb. d. Rad. und Elektr. **8**, 83 (1911).
- Kohlschutter Jahrbuch. d. Radioakt **9**, 355 (1912).
- H. B. Williams, Phys. Rev. **2**, 402 (1913).
- O. Steelman, Phys. Rev. **6**, 330 (1913).
- C. W. C. Kaye, Proc. Phys. Soc. Lon. **25**, 198 (1913).
- C. Bergholm, Am. Physik **43**, 1-23 (1914).
- W. Planck, Phys. Zeits. **563** (1914).
- W. F. G. Swann, Phil. Mag. **28**, 467 (1914).
- A. M. Tyndall and H. G. Hughes, Phil. Mag. **27**, 415 (1914).
- B. Pogany, Phys. Zeits. **15**, 688 (1914).
- Nicholson, Phys. Rev. **3**, 1 (1914).
- H. B. Williams, Phys. Rev. **4**, 517 (1914).
- B. Pogany, Phys. Zeits. **17**, 251 (1916).
- W. Reinders und L. Hamburger, K. Akad. Amst. Proc. **19**, 958 (1917).
- R. W. King, Phys. Rev. **10**, 292 (1917).
- Fabry and Bursson, Jour. de Phys. June, (1919).
- J. A. Becker, L. F. Curtiss, Phys. Rev. **15**, 457 (1920).
- J. J. Thompson, "Rays of Positive Electricity," 121 (1921).
- H. Kahler, Phys. Rev. **18**, 210 (1921).
- F. Gross, Zeits. f. Physik **6**, 376 (1921).
- Kingdon and Langmuir, Phys. Rev. **20**, 107 (1922).
- F. Gross, Zeits. f. Physik **16**, 40-5 (1923).
- K. H. Kingdon, Phys. Rev. **21**, 210 (1923).
- Kingdon and Langmuir, Phys. Rev. **22**, 148 (1923).
- Res. Staff G. E. (London) Phil. Mag. **45**, 98 (1923).
- K. Lauch, Ann. d. Physik **74**, 55 (1924).
- S. S. MacKeown, Phys. Rev. **23**, 85 (1924).
- L. R. Ingersoll and S. S. de Vinney, Phys. Rev. **26**, 86 (1925).
- J. Mazur, Bull. Acad. Polonaise, 81 (1925).
- H. Dewhurst, Phys. Soc. **39**, 39 (1926).
- A. Guntherschutze, Zeits. f. Physik **36**, 8, 563 (1926).
- L. A. Fourdes, Ind. Assoc. Cult. Sci. Proc. **323** (1926).
- A. Guntherschutze, Zeits. f. Physik **38**, 8, 575 (1926).
- E. Blechaschmidt, Ann. d. Physik **81**, 999 (1926).
- A. v. Hippel, Ann. d. Physik **80**, 7, 672 (1926).
- F. Joliot, Compt. Rend. **196** (1926).
- "Cathode Disintegration" Engineering **410** (1927).
- F. W. Warburton, Phys. Rev. **30**, 673 (1927).
- B. Steinberg, Phys. Rev. **29**, 352 (1927).
- A. Andant, Rev. d'Optique **6**, 364 (1927).
- A. Andant, Rev. d'Optique **6**, 81, 1043 (1927).
- T. Baum, Zeit. f. Physik **40**, 9, 686 (1927).
- A. Ferry, Jour. de Phys. **9**, 39 (1928).
- A. Ferry, Compt. Rend. **187** (1928).
- H. Nagaoka and T. Fretagami, Imp. Acad. Tokyo Proc. **4**, 20 (1928).

- L. R. Ingersoll and L. O. Sordahl, *Phys. Rev.* **32**, 649 (1928).
R. S. Bartlett, *Phil. Mag.* **5**, 848 (1928).
L. R. Ingersoll and J. D. Hanawalt, *Phys. Rev.* **34**, 972 (1929).
T. Asada and K. Quasaborth, *Zeits. f. physik. Chem.* **5-6**, 143 (1929).
Sophie Dembenska, *Zeits. f. Physik* **54**, 1 and 2 (1929).
F. Smith, *U.S.P.* **1**, 710, 747 (1929).
A. Knapp, *Am. Cer. Soc. Jour.* **13**, No. 11 (1930).
L. R. Ingersoll, *Nature*, **126**, 204 (1930).
L. Van Atta, *Rev. Sci. Inst.* **1**, 687 (1930).
F. Joliot, *Compt. Rend.* **190**, 627 (1930).
E. Perucca *Ann. d. Physik* **4**, **2**, 252 (1930).
C. H. Cartwright, *Rev. Sci. Inst.* **1**, 758 (1930).
F. Joliot, *Ann. d. Physik* **15**, 418 (1931).
Klemensiewicz and Waswicz, *Zeits. f. Physik* **71**, 11 and 12, 817 (1931).